

S STANDARD EQUIPMENT

- Alternator, 60 Ampere, 24V
- Auto-decel
- Automatic engine warm-up system
- Batteries, 126 Ah/2 x 12V
- Boom holding valve
- ROPS cab (ISO 12117-2)
- Corrosion resistor
- Counterweight
- Dry type air cleaner, double element
- Electric horn
- Engine, Komatsu SAA6D114E-3
- Engine overheat prevention system
- Fan guard structure
- Hydraulic track adjusters (each side)
- Long lubricating intervals for implement bushings
- Multi-function color monitor
- Power maximizing system
- PPC hydraulic control system
- Radiator & oil cooler dust proof net
- Rear reflector
- Rear view mirror, RH, LH, rear, sidewise
- Seat belt, retractable
- Starting motor, 7.5 kW/24 v x 1
- Suction fan
- Track roller guards (full length)
- Track roller
 - PC350-8, 7 each side
 - PC350LC-8, 8 each side
- Track shoe
 - PC350-8, 600 mm 24" triple grouser
 - PC350LC-8, 600 mm 24" triple grouser
- Travel alarm
- Two-mode settings for boom
- Working light, 2 (boom and RH)
- Working mode selection system

***** OPTIONAL EQUIPMENT

- Additional filter system for poor-quality fuel
- Air conditioner with defroster
- Arm, 3185 mm 10'5" arm assembly, heavy-duty
- Batteries, 140 Ah/2 x 12 V
- Bolt-on top guard (Operator Protective Guards level 2 (OPG))
- Boom, 6470 mm 21'3", heavy-duty
- Cab accessories
 - Rain visor
 - Sun visor
- Cab front guard
 - Full height guard
 - Half height guard
- Cab with 2-piece pull up front window
- Heater with defroster
- Rear view monitoring system
- Seat, suspension
- Seat, suspension with heater
- Service valve
- Track frame undercover
- Working lights, 2 on cab

SPECIAL PURPOSE BUCKET

- **Ripper bucket** for hard and rock ground
 - Capacity
 - SAE heaped **0.9 m³** 1.18 yd³
 - CECE heaped **0.8 m³** 1.05 yd³
 - Width **1200 mm** 47.2"

www.Komatsu.com

Printed in Japan 201201 IP.As

KOMATSU[®]

CEN00222-03

Materials and specifications are subject to change without notice.
KOMATSU is a trademark of Komatsu Ltd. Japan.

KOMATSU[®]

PC350-8
PC350LC-8

HORSEPOWER
Gross: 194 kW 260 HP @ 1950 rpm
Net: 184 kW 246 HP @ 1950 rpm

OPERATING WEIGHT
PC350-8: 32600–32960 kg
 71,870–72,660 lb
PC350LC-8: 33660–34040 kg
 74,210–75,040 lb

ecot3

PC
350



Photo may include optional equipment.

HYDRAULIC EXCAVATOR

WALK-AROUND

Productivity Features

• High Production and Low Fuel Consumption

High power, working performance and fuel efficiency improve production and fuel costs.

• Large Drawbar Pull

provides superb steering and slope climbing performance.

• Large Digging Force

Pressing the Power Max function button temporarily increases the digging force 7%.

• Two-mode Setting for Boom

Switch selection allows either powerful digging or smooth boom operation.

See page 5.

Large TFT LCD Monitor

- Easy-to-see and use 7" large multi-function color monitor
- Can be displayed in 12 languages for global support.

TFT : Thin Film Transistor
LCD : Liquid Crystal Display

See page 8.

Safety Design

- ROPS cab (ISO 12117-2)
- Anti-slip plates for safe work on machine
- Safety enhancement with large side-view, sidewise, and rear mirrors added.
- Rear view monitoring system for easy checking behind the machine (optional)

See page 7.



Ecology and Economy Features

- Low emission engine
A powerful turbocharged and air to air aftercooled Komatsu SAA6D114E-3 engine provides **184 kW** 246 HP. This engine is EPA Tier 3 and EU Stage 3A emissions certified, without sacrificing power or machine productivity.
- Economy mode saves fuel consumption.
- Low operation noise
See pages 4 and 5.

Large Comfortable Cab

- Low-noise cab
- Low vibration with cab damper mounting
- Highly pressurized cab with optional air conditioner
- Operator seat and console with armrest that enables operations in the appropriate operational posture.
See page 6.

Easy Maintenance

- Long replacement interval of engine oil, engine oil filter, hydraulic oil and hydraulic filter.
- Equipped with fuel pre-filter as standard (with water separator)
- Side-by-side radiator and oil cooler configuration enables independent removal and installation of those two components.
- Equipped with the EMMS monitoring system.
- Easy access to engine oil filter and fuel drain valve
- Large fuel tank capacity

See page 9.

HORSEPOWER
Gross: 194 kW 260 HP @ 1950 rpm
Net: 184 kW 246 HP @ 1950 rpm

OPERATING WEIGHT
PC350-8: 32600 – 32960 kg
71,870 – 72,660 lb
PC350LC-8: 33660 – 34040 kg
74,210 – 75,040 lb

BUCKET CAPACITY
1.4 m³
1.83 yd³

Photo may include optional equipment.

PRODUCTIVITY & ECOLOGY FEATURES

Komatsu Technology



Komatsu develops and produces all major components, such as engines, electronics and hydraulic components, in house. With this "Komatsu Technology," and adding customer feedback, Komatsu is achieving great advancements in technology. To achieve both high levels of productivity and economical performance, Komatsu has developed the main components with a total control system. The result is a new generation of high performance and environment friendly excavators.

Environment-friendly Clean Engine

The PC350-8 gets its exceptional power and work capacity from a Komatsu SAA6D114E-3 engine. Output is **184 kW** 246 HP, providing increased hydraulic power and improved fuel efficiency.

Komatsu SAA6D114E-3 engine is EPA Tier 3 and EU Stage 3A emissions certified and reduced NOx emission by 40%.

The SAA6D114E-3 engine adopts the electronically controlled Heavy Duty HPCR* fuel injection system.

*HPCR : High Pressure Common Rail

Hydraulics

Unique two-pump system ensures smooth compound movement of the work equipment. HydraulMind controls both pumps for efficient engine power use. This system also reduces hydraulic loss during operation.

Low Operation Noise

Enables a low noise operation using the low-noise engine and methods to cut noise at source. Ambient noise meets the EU Stage 2 noise regulation.

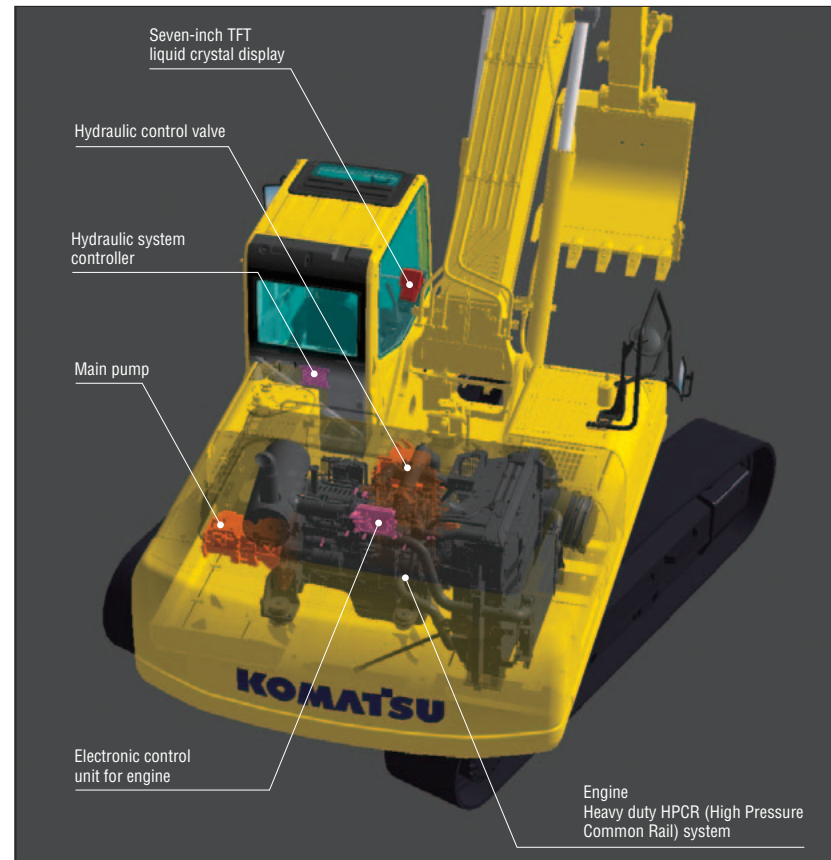

Working Modes Selectable

Two established work modes are further improved.

P mode – Power or work priority mode has low fuel consumption, but fast equipment speed and maximum production and power are maintained.

E mode – Economy or fuel priority mode further reduces fuel consumption, but maintains the P-mode-like working equipment speed for light duty work.

You can select Power or Economy modes using a one-touch operation on the monitor panel depending on workloads.

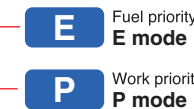

Eco-gauge that Assists Energy-saving Operations

Equipped with the Eco-gauge that can be recognized at a glance on the right of the multi-function color monitor for environment-friendly energy-saving operations. Allows focus on operation in the green range with reduced CO₂ emissions and efficient fuel consumption.



Eco-gauge

Idling Caution

To prevent unnecessary fuel consumption, an idling caution is displayed on the monitor, if the engine idles for 5 minutes or more.



Larger Maximum Drawbar Pull

Larger maximum drawbar pull provides superb steering and slope climbing performance.

Maximum drawbar pull:
264 kN 26900 kgf
59,300 lb



Large Digging Force

With the one-touch Power Max. function digging force has been further increased. (8.5 seconds of operation)

Maximum arm crowd force (ISO):
160 kN (16.3t) → **171 kN (17.4t)** **7% UP**
(with Power Max.)

Maximum bucket digging force (ISO):
213 kN (21.7t) → **228 kN (23.2t)** **7% UP**
(with Power Max.)

*Measured with Power Max function, 3185 mm 10'5" arm and ISO rating

Smooth Loading Operation

Two return hoses improve hydraulic performance. In the arm out function, a portion of the oil is returned directly to the tank providing smooth operation.



Two-mode Setting for Boom

Smooth mode provides easy operation for gathering blasted rock or scraping down operation. When maximum digging force is needed, switch to Power mode for more effective excavating.

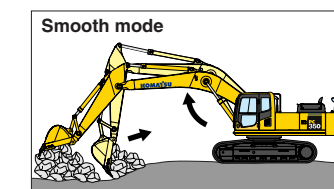

Boom floats upward, reducing lifting of machine front. This facilitates gathering blasted rock and scraping down operations.

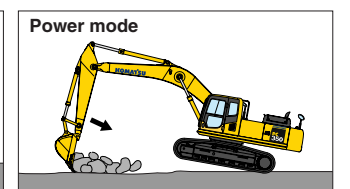

Boom pushing force is increased, ditch digging and box digging operation on hard ground are improved.

WORKING ENVIRONMENT



Low Cab Noise

The newly-designed cab is highly rigid and has excellent sound absorption ability. Thorough improvement of noise source reduction and use of low noise engine, hydraulic equipment, and air conditioner allows this machine to generate a low level of noise.

Low Vibration with Cab Damper Mounting

PC350-8 uses viscous damper mounting for cab that incorporates longer stroke and the addition of a spring. The new cab damper mounting combined with high rigidity deck aids vibration reduction at operator seat.

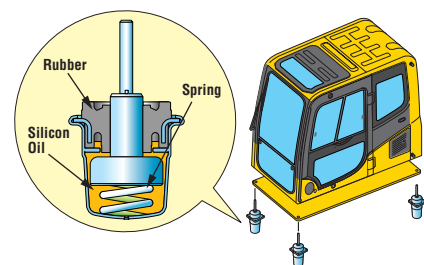

Wide Newly-designed Cab

Newly-designed wide spacious cab includes seat with reclining backrest. The seat height and longitudinal inclination are easily adjusted using a pull-up lever. You can set the appropriate operational posture of armrest together with the console. Reclining the seat further enables you to place it into the fully flat state with the headrest attached.



Pressurized Cab

Optional air conditioner, air filter and a higher internal air pressure (+9.0 mm Aq +0.35"Aq) prevent external dust from entering the cab.

Automatic Air Conditioner (optional)

Enables you to easily and precisely set cab atmosphere with the instruments on the large LCD. The bi-level control function keeps the operator's head and feet cool and warm respectively. This improved air flow function keeps the inside of the cab comfortable throughout the year. Defroster function keeps front glass clear.

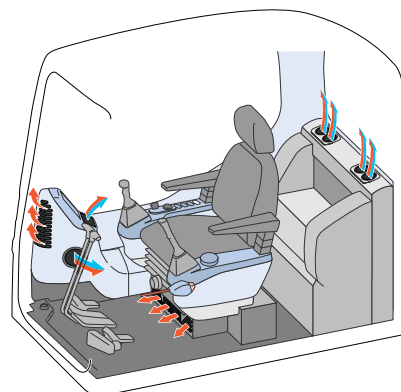

Safety Features

ROPS Cab

The machine is equipped with a ROPS cab that conforms to ISO 12117-2 for excavators as standard equipment. The ROPS cab has high shock-absorption performance, featuring excellent durability and impact strength. It also satisfies the requirements of ISO OPG top guard level 1 for falling objects. Combined with the retractable seat belt, The ROPS cab protects the operator in case of tipping over and against falling objects.

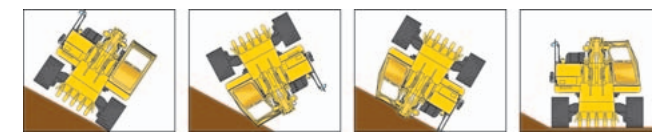

Anti-slip Plates

Highly durable anti-slip plates maintain superior traction performance for the long term.



Lock Lever

Locks the hydraulic pressure to prevent unintentional movement. Neutral start function allows machine to be started only in lock position.



Large Side-view, Rear, and Sidewise Mirrors

Enlarged left-side mirror and addition of rear and side mirror allow the PC350-8 to meet the new ISO visibility requirements.

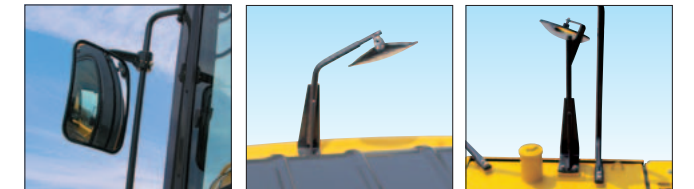

Pump/engine Room Partition

Pump/engine room partition prevents oil from spraying onto the engine if a hydraulic hose should burst.

Thermal and Fan Guards

Thermal and fan guards are placed around high-temperature parts of the engine and fan drive.



MAINTENANCE FEATURES

Large LCD Color Monitor

Large Multi-lingual LCD Monitor

A large user-friendly color monitor enables safe, accurate and smooth work. Improved screen visibility is achieved by the use of TFT liquid crystal display that can easily be read at various angles and lighting conditions. Simple and easy to operate switches. Function keys facilitate multi-function operations. Displays data in 12 languages to globally support operators around the world.



- Indicators**
- 1 Auto-decelerator
 - 2 Working mode
 - 3 Travel speed
 - 4 Engine water temperature gauge
 - 5 Hydraulic oil temperature gauge
 - 6 Fuel gauge
 - 7 Eco-gauge
 - 8 Function switches menu

- Basic operation switches**
- 1 Auto-decelerator
 - 2 Working mode selector
 - 3 Traveling selector
 - 4 Buzzer cancel
 - 5 Wiper
 - 6 Windshield washer

Mode Selection

The multi-function color monitor has Power mode, Economy mode, Lifting mode, Breaker mode and Attachment mode.

Working Mode	Application	Advantage
P	Power mode	<ul style="list-style-type: none"> Maximum production/power Fast cycle time
E	Economy mode	<ul style="list-style-type: none"> Excellent fuel economy
L	Lifting mode	<ul style="list-style-type: none"> Hydraulic pressure is increased by 7%
B	Breaker operation	<ul style="list-style-type: none"> Optimum engine rpm, hydraulic flow
ATT	Attachment mode	<ul style="list-style-type: none"> Optimum engine rpm, hydraulic flow, 2 way

Lifting Mode

When the Lifting mode is selected, lifting capacity is increased 7% by raising hydraulic pressure.

EMMS

(Equipment Management Monitoring System)

Monitor Function

Controller monitors engine oil level, coolant temperature, battery charge and air clogging, etc. If controller finds any abnormality, it is displayed on the LCD.



Maintenance Function

Monitor informs replacement time of oil and filters on LCD when the replacement interval is reached.



Trouble Data Memory Function

Monitor stores abnormalities for effective troubleshooting.

Easy Maintenance

Easy Radiator Cleaning

Since radiator and oil cooler are arranged side-by-side, it is easy to clean, remove and install them.

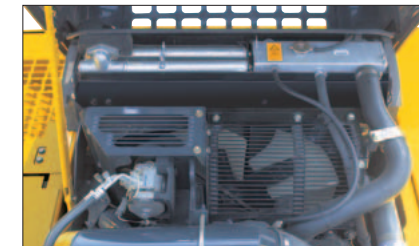

Equipped with the Eco-drain Valve as Standard

Prevents clothes and the ground from becoming contaminated due to oil leakage when replacing the engine oil.

High-capacity Air Cleaner

High capacity air cleaner is comparable to that of larger machines. The larger air cleaner can extend air cleaner life during long-term operation and prevents early clogging and resulting power decrease. Reliability is improved by a new seal design.



Large Fuel Tank Capacity

Large fuel tank capacity extends operating hours before refueling. Fuel tank is treated for rust prevention and improved corrosion resistance.

Easy Access to Engine Oil Filter and Fuel Drain Valve

Engine oil level gauge, and fuel filter are one side mounted to improve accessibility. Engine oil filter and fuel drain valve are remotely mounted to improve accessibility.



Engine Oil Filter



Fuel Drain Valve

Long Work Equipment Greasing Interval

High quality BMRC bushings and resin shims are optionally available for work equipment pins excluding bucket, extending greasing interval to 500 hours.

Equipped with the Fuel Pre-filter (with Water Separator)

Removes water and contaminants in the fuel to prevent fuel problems.



Long-life Oil, Filter

Uses high-performance filtering materials and long-life oil. Extends the oil and filter replacement interval.



Hydraulic oil filter (Eco-white element)

- Engine oil & Engine oil filter every 500 hours
- Hydraulic oil every 5000 hours
- Hydraulic oil filter every 1000 hours



Photo may include optional equipment.

QUARRY HYDRAULIC EXCAVATOR

The PC350-8 is a specially designed heavy-duty machine. The PC350-8 has strengthened work equipment and various machine body parts for use in severe job sites such as quarry and gravel gathering, etc.

Cab with Two-piece Pull-up Window (optional)



Fixed One-piece Laminated Front Window Glass

The front window is fixed and uses laminated safety glass to prevent scattering of glass fragments when broken.



Photo may include optional equipment.

Fixed Skylight and Sunshade



Large Counterweight

The PC350-8 counterweight is increased by **900 kg 1,980 lb** for better stability.



Dent Preventing Plates



Heavy-duty Boom

Heavy-duty Arm

Photo may include optional equipment.

Deck Guard



Strengthened Revolving Frame Undercover



Full Roller Guard



Double-flange Track Roller

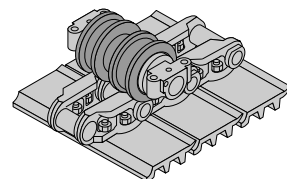

Double-flange roller guides track link correctly and extends life of undercarriage.

Number of double-flange track rollers
 PC350-83 each side
 PC350LC-84 each side

Side Reinforcement Plates
 16 mm 0.63" thickness high-tensile strength steel used.

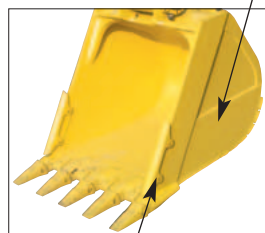

Side Shrouds

O-ring Added
 O-ring is added between bucket and linkage to prevent entrance of dirt.

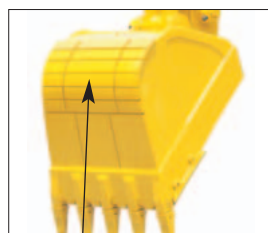

Bottom Wear Plate
 19 mm 0.75" thickness high-tensile strength steel used.

Corner Tooth Adapters

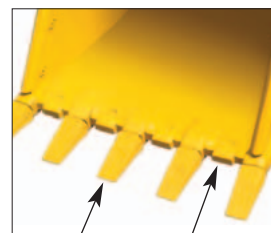

Long Life Bucket Teeth
Lip Shrouds

Quarry Bucket and Work Equipment

PC350-8 bucket is designed exclusively for quarry use and is higher strength for impact and wear. Various parts of work equipment are also strengthened.

SPECIFICATIONS



ENGINE

Model Komatsu SAA6D114E-3
 Type Water-cooled, 4-cycle, direct injection
 Aspiration Turbocharged, aftercooled
 Number of cylinders 6
 Bore 114 mm 4.49"
 Stroke 135 mm 5.31"
 Piston displacement 8.27 ltr 505 in³
 Horsepower:
 SAE J1995 Gross **194 kW** 260 HP
 ISO 9249 / SAE J1349 Net **184 kW** 246 HP
 Rated rpm 1950 rpm
 Fan drive type Mechanical
 Governor All-speed control, electronic

EPA Tier 3 and EU Stage 3A emissions certified.



HYDRAULICS

Type HydraMind (Hydraulic Mechanical Intelligence New Design) system, closed-center system with load sensing valves and pressure compensated valves
 Number of selectable working modes 4
 Main pump:
 Type Two-variable displacement piston type
 Pumps for Boom, arm, bucket, swing, and travel circuits
 Maximum flow **535 ltr/min** 141 U.S. gal/min
 Supply for control circuit Self-reducing valve
 Hydraulic motors:
 Travel 2 x axial piston motors with parking brake
 Swing 1 x axial piston motor with swing holding brake
 Relief valve setting:
 Implement circuits **37.3 MPa** 380 kgf/cm² 5,400 psi
 Travel circuit **37.3 MPa** 380 kgf/cm² 5,400 psi
 Swing circuit **27.9 MPa** 285 kgf/cm² 4,050 psi
 Pilot circuit **3.2 MPa** 33 kgf/cm² 470 psi
 Hydraulic cylinders:
 (Number of cylinders – bore x stroke x rod diameter)
 Boom **2-140 mm x 1480 mm x 100 mm** 5.5" x 58.3" x 3.9"
 Arm **1-160 mm x 1825 mm x 110 mm** 6.3" x 71.9" x 4.3"
 Bucket **1-140 mm x 1285 mm x 100 mm** 5.5" x 50.6" x 3.9"



DRIVES AND BRAKES

Steering control Two levers with pedals
 Drive method Hydrostatic
 Maximum drawbar pull **264 kN** 26900 kgf 59,300 lb
 Gradeability 70%, 35°
 Maximum travel speed (Auto-Shift):
 High **5.5 km/h** 3.4 mph
 Mid **4.5 km/h** 2.8 mph
 Low **3.2 km/h** 2.0 mph
 Service brake Hydraulic lock
 Parking brake Mechanical disc brake



SWING SYSTEM

Drive method Hydrostatic
 Swing reduction Planetary gear
 Swing circle lubrication Grease-bathed
 Service brake Hydraulic lock
 Holding brake/Swing lock Mechanical disc brake
 Swing speed 9.5 rpm



UNDERCARRIAGE

Center frame X-frame
 Track frame Box-section
 Seal of track Sealed track
 Track adjuster Hydraulic
 Number of shoes (each side):
 PC350-8 45
 PC350LC-8 48
 Number of carrier rollers 2 each side
 Number of track rollers (each side):
 PC350-8 7
 PC350LC-8 8



COOLANT AND LUBRICANT CAPACITY (REFILLING)

Fuel tank **605 ltr** 160 U.S. gal
 Coolant **32.0 ltr** 8.5 U.S. gal
 Engine **35.0 ltr** 9.2 U.S. gal
 Final drive, each side **9.0 ltr** 2.4 U.S. gal
 Swing drive **16.5 ltr** 4.4 U.S. gal
 Hydraulic tank **188 ltr** 49.7 U.S. gal



OPERATING WEIGHT (APPROXIMATE)

Operating weight including **6470 mm** 21'3" one-piece boom, **3185 mm** 10'5" arm, SAE heaped **1.4 m³** 1.83 yd³ bucket, rated capacity of lubricants, coolant, full fuel tank, operator, and standard equipment.

Shoes	PC350-8		PC350LC-8	
	Operating Weight	Ground Pressure	Operating Weight	Ground Pressure
600 mm 24"	32600 kg 71,870 lb	65.7 kPa 0.67 kgf/cm ² 9.53 psi	33660 kg 74,210 lb	62.9 kPa 0.64 kgf/cm ² 9.12 psi
700 mm 28"	32960 kg 72,660 lb	57.1 kPa 0.58 kgf/cm ² 8.28 psi	34040 kg 75,040 lb	54.5 kPa 0.56 kgf/cm ² 7.90 psi



DIMENSIONS

Arm Length	3185 mm 10'5"	
Model	PC350-8	PC350LC-8
A Overall length	11140 mm 36'7"	11140 mm 36'7"
B Length on ground	5755 mm 18'11"	5930 mm 19'5"
C Overall height (to top of boom)*	3285 mm 10'9"	3285 mm 10'9"
D Overall width	3190 mm 10'6"	3190 mm 10'6"
E Overall height (to top of cab)*	3145 mm 10'4"	3145 mm 10'4"
F Ground clearance, counterweight	1185 mm 3'11"	1185 mm 3'11"
G Ground clearance (minimum)	500 mm 1'8"	500 mm 1'8"
H Tail swing radius	3450 mm 11'4"	3450 mm 11'4"
I Track length on ground	3700 mm 12'2"	4030 mm 13'3"
J Track length	4625 mm 15'2"	4955 mm 16'3"
K Track gauge	2590 mm 8'6"	2590 mm 8'6"
L Width of crawler	3190 mm 10'6"	3190 mm 10'6"
M Shoe width	600 mm 24"	600 mm 24"
N Grouser height	36 mm 1.4"	36 mm 1.4"
O Machine cab height	2585 mm 8'6"	2585 mm 8'6"
P Machine cab width	3165 mm 10'5"	3165 mm 10'5"
Q Distance, swing center to rear end	3405 mm 11'2"	3405 mm 11'2"

*: Including grouser height

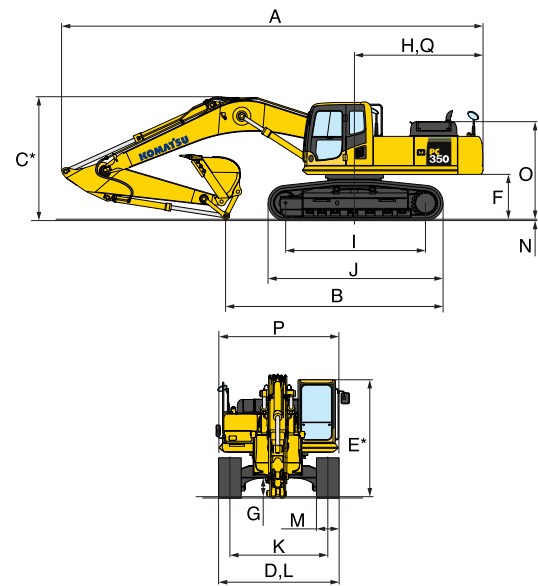

WORKING RANGE

Arm Length	3185 mm 10'5"	
A Max. digging height	10100 mm 33'2"	
B Max. dumping height	7050 mm 23'2"	
C Max. digging depth	7380 mm 24'3"	
D Max. vertical wall digging depth	6400 mm 21'0"	
E Max. digging depth of cut for 8' level	7180 mm 23'7"	
F Max. digging reach	11100 mm 36'5"	
G Max. digging reach at ground level	10920 mm 35'10"	
H Min. swing radius	4310 mm 14'2"	
SAE rating	Bucket digging force at power max.	200 kN/20400 kgf/44,970 lb
	Arm crowd force at power max.	165 kN/16800 kgf/37,040 lb
ISO rating	Bucket digging force at power max.	228 kN/23200 kgf/51,150 lb
	Arm crowd force at power max.	171 kN/17400 kgf/38,360 lb

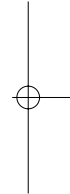
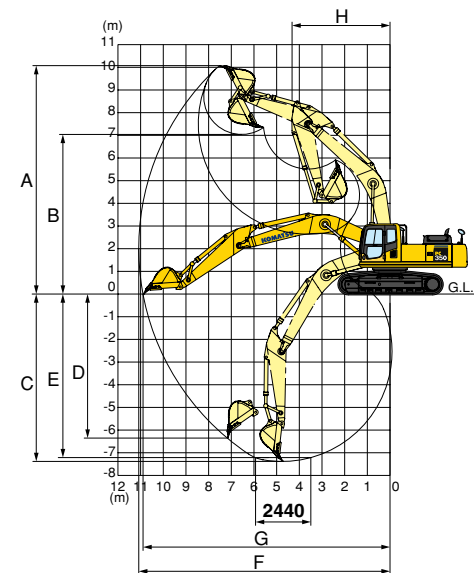

BACKHOE BUCKET, ARM, AND BOOM COMBINATION

Bucket Capacity (heaped)		Width		Weight	Number of Teeth	Arm Length 3185 mm 10'5"
SAE, PCSA	CECE	With Side Shrouds	Without Side Shrouds	With Side Shrouds		
*1.40 m ³ 1.83 yd ³	1.20 m ³ 1.57 yd ³	1458 mm 57.4"	—	1508 kg 3,320 lb	5	○

○ General purpose use, material density up to 1.8 ton/m³ 1.52 U.S. ton/yd³

* Quarry bucket

LIFTING CAPACITY WITH LIFTING MODE

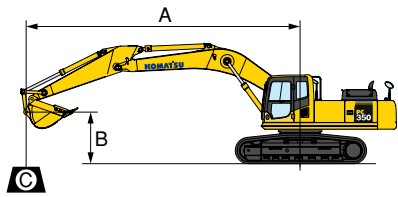

- A: Reach from swing center
- B: Bucket hook height
- C: Lifting capacity
- Cf: Rating over front
- Cs: Rating over side
- ⊙: Rating at maximum reach

PC350-8		Arm: 3185 mm 10'5"		Bucket: 1.40 m ³ 1.83 yd ³ SAE heaped				Shoe: 600 mm 24" triple grouser					
B	A	⊙ MAX		9.0m 29'		7.5 m 24'		6.0 m 19'		4.5 m 14'		3.0 m 9'	
		Cf	Cs	Cf	Cs	Cf	Cs	Cf	Cs	Cf	Cs	Cf	Cs
7.5 m 24'		*4900 kg *10,800 lb	*4900 kg *10,800 lb			*6400 kg *14,200 lb	5550 kg 12,300 lb						
6.0 m 19'		*4800 kg *10,600 lb	3950 kg 8,800 lb			*6750 kg *14,800 lb	5500 kg 12,100 lb						
4.5 m 14'		*4950 kg *10,900 lb	3350 kg 7,400 lb	5500 kg 12,100 lb	3600 kg 8,000 lb	*7300 kg *16,100 lb	5250 kg 11,600 lb	*8700 kg *19,200 lb	7950 kg 17,500 lb				
3.0 m 9'		4750 kg 10,500 lb	3050 kg 6,700 lb	5350 kg 11,800 lb	3450 kg 7,700 lb	7450 kg 16,400 lb	4950 kg 11,000 lb	*10100 kg *22,300 lb	7400 kg 16,300 lb	*14400 kg *31,700 lb	11950 kg 26,300 lb		
1.5 m 4'		4600 kg 10,200 lb	2900 kg 6,400 lb	5150 kg 11,400 lb	3300 kg 7,300 lb	7150 kg 15,700 lb	4700 kg 10,300 lb	10400 kg 23,000 lb	6850 kg 15,100 lb	*16100 kg *35,500 lb	10850 kg 23,900 lb		
0 m 0'		4700 kg 10,400 lb	2950 kg 6,500 lb	5050 kg 11,100 lb	3200 kg 7,000 lb	6900 kg 15,200 lb	4450 kg 9,900 lb	10000 kg 22,100 lb	6500 kg 14,300 lb	16400 kg 36,100 lb	10300 kg 22,700 lb		
-1.5 m -4'		5100 kg 11,200 lb	3200 kg 7,100 lb	5000 kg 11,000 lb	3150 kg 6,900 lb	6750 kg 14,900 lb	4350 kg 9,600 lb	9800 kg 21,600 lb	6300 kg 13,900 lb	16200 kg 35,700 lb	10150 kg 22,400 lb	*9050 kg *19900 lb	*9050 kg *19900 lb
-3.0 m -9'		5900 kg 13,000 lb	3800 kg 8,300 lb			6750 kg 14,900 lb	4350 kg 9,600 lb	9800 kg 21,600 lb	6300 kg 13,900 lb	*14900 kg *32,800 lb	10250 kg 22,600 lb	*17300 kg *38,200 lb	*17300 kg *38,200 lb
-4.5 m -14'		*6950 kg *15,300 lb	5050 kg 11,100 lb					*9200 kg *20,200 lb	6500 kg 14,300 lb	*12250 kg *27,000 lb	10550 kg 23,300 lb	*15900 kg *35,100 lb	*15900 kg *35,100 lb
-6.0 m -19'		*5700 kg *12,600 lb	*5700 kg *12,600 lb							*7550 kg *16,600 lb	*7550 kg *16,600 lb		

PC350LC-8		Arm: 3185 mm 10'5"		Bucket: 1.40 m ³ 1.83 yd ³ SAE heaped				Shoe: 600 mm 24" triple grouser					
B	A	⊙ MAX		9.0m 29'		7.5 m 24'		6.0 m 19'		4.5 m 14'		3.0 m 9'	
		Cf	Cs	Cf	Cs	Cf	Cs	Cf	Cs	Cf	Cs	Cf	Cs
7.5 m 24'		*4900 kg *10,800 lb	*4900 kg *10,800 lb			*6400 kg *14,200 lb	5750 kg 12,600 lb						
6.0 m 19'		*4800 kg *10,600 lb	4100 kg 9,000 lb			*6750 kg *14,800 lb	5650 kg 12,500 lb						
4.5 m 14'		*4950 kg *10,900 lb	3500 kg 7,700 lb	6350 kg 14,100 lb	3750 kg 8,300 lb	*7300 kg *16,100 lb	5450 kg 12,000 lb	*8700 kg *19,200 lb	8150 kg 18,000 lb				
3.0 m 9'		*5300 kg *11,700 lb	3150 kg 7,000 lb	6200 kg 13,700 lb	3600 kg 7,900 lb	*8100 kg *17,900 lb	5100 kg 11,300 lb	*10100 kg *22,300 lb	7600 kg 16,800 lb	*14400 kg *31,700 lb	12250 kg 27,000 lb		
1.5 m 4'		5400 kg 11,900 lb	3050 kg 6,700 lb	6050 kg 13,300 lb	3450 kg 7,600 lb	8300 kg 18,300 lb	4850 kg 10,700 lb	*11400 kg *25,100 lb	7100 kg 15,600 lb	*16100 kg *35,500 lb	11150 kg 24,600 lb		
0 m 0'		5500 kg 12,200 lb	3100 kg 6,800 lb	5900 kg 13,000 lb	3300 kg 7,300 lb	8050 kg 17,800 lb	4650 kg 10,200 lb	11700 kg 25,900 lb	6700 kg 14,800 lb	*16900 kg *37,200 lb	10600 kg 23,400 lb		
-1.5 m -4'		5950 kg 13,200 lb	3350 kg 7,400 lb	5850 kg 12,900 lb	3250 kg 7,200 lb	7950 kg 17,500 lb	4500 kg 9,900 lb	11500 kg 25,400 lb	6500 kg 14,400 lb	*16400 kg *36,100 lb	10450 kg 23,100 lb	*9050 kg *19,900 lb	*9050 kg *19,900 lb
-3.0 m -9'		6950 kg 15,300 lb	3900 kg 8,600 lb			7950 kg 17,500 lb	4500 kg 9,900 lb	*11150 kg *24,500 lb	6500 kg 14,400 lb	*14900 kg *32,800 lb	10600 kg 23,300 lb	*17300 kg *38,200 lb	*17300 kg *38,200 lb
-4.5 m -14'		*6950 kg *15,300 lb	5200 kg 11,500 lb					*9200 kg *20,200 lb	6700 kg 14,800 lb	*12250 kg *27,000 lb	10850 kg 24,000 lb	*15900 kg *35,100 lb	*15900 kg *35,100 lb
-6.0 m -19'		*5700 kg *12,600 lb	*5700 kg *12,600 lb							*7550 kg *16,600 lb	*7550 kg *16,600 lb		

*Load is limited by hydraulic capacity rather than tipping. Ratings are based on SAE standard No. J1097. Rated loads do not exceed 87% of hydraulic lift capacity or 75% of tipping load.